

ECODryBlock

Dry block heater

Modular and digital dry block heater designed for accurate sample heating, supporting a wide range of applications in Life Science and Environmental laboratories.

velp®

Driven by curiosity



ECODryBlock

ECODryBlock is a modular, digital, and precise dry block heater designed for sample preparation, incubation, DNA denaturation, enzymatic reactions, culture media tests, and COD analysis.

One Modular System

- A single ControlPad manages up to two heating Modules, each with space for up to 2 small aluminum blocks (76x51x95 mm) or 1 big aluminum block (152x51x95 mm)
- Set independent timers and temperatures (up to 165 °C) on each Module
- A wide range of interchangeable aluminum blocks, designed to accommodate different types of vials, tubes, and cuvette

Uniform, Stable, and Controlled Conditions

- The transparent cover creates a warm air jacket that minimizes heat loss and ensures uniform temperature distribution
- External probes (Pt100 and Pt1000) enable precise monitoring and control directly within the block or the sample vessel
- Possibility to set different temperatures on each Module, effectively working as two dry baths in one

Advanced User Experience

- Equipped with a 7" capacitive touch screen with chemical-resistant glass surface
- Modern, user-friendly interface for quick parameter setting and intuitive operation
- Engineered for durability, with a 3-year warranty



Configurations



ECODryBlock System



ECODryBlock System COD 24



ECODryBlock System COD 4



ECODryBlock No ControlPad

Optional Accessories

Clamp with probe support	A0000280
Handle for block removal	A0000351
Support rod	A00001069
Transparent lid	A00000493
Kit ECODryBlock junction	A00000531
Sample rack for A00000529*	A00000532
Air condenser with ground cone*	A00001041
Antisplash bell*	A00001045
PTFE sheaths for 29/32 cones*	A00001042
Test tube COD Ø42x200mm 200ml, 3pcs/box*	A00000145
Condenser 200 mm, type KS*	CA0091667
Holder for 12 round glass cells*	CA0091636
Set of 20 glass test tube Ø 16 mm*	CM0091680
Tube for sample decomposition Ø22 mm*	CA0091666
Absorption attachment for condenser*	10000002

*for COD analysis only

External Temperature Sensors

Temperature probes ensure precise temperature control for accurate and reproducible results.



A00000458
Pt1000
Temperature
Probe AISI 316 Ti
Ø3 mm



A00000268
Pt100
Temperature
Probe AISI 316 Ti
Ø3mm

Instrument - Codes

		ECODryBlock
ECODryBlock System	115 V - 230 V	SA101A0700
ECODryBlock System COD 24	115 V - 230 V	SB101A0700
ECODryBlock System COD 4	115 V - 230 V	SC101A0700
ECODryBlock no ControlPad*	115 V - 230 V	F101A0700

*addition to the system



Blocks for Standard Test Tubes

Commonly used for general laboratory heating tasks, such as preparing solutions, dissolving substances, or incubating samples in routine chemical and biological analyses.

Velp code	Description	Suitable for	Well Size	No. of Wells	Well Depth
A00000495	STT-W30-D060-A Block	Round bottom tubes (6mm)	Ø 8.3	30	48.4
A00000496	STT-W24-D100-A Block	Round bottom tubes (10mm)	Ø 10.7	24	48.4
A00000497	STT-W16-D130-A Block	Round bottom tubes (12/13 mm)	Ø 13.9	16	48.4
A00000498	STT-W20-D130-A Block	Round bottom tubes (12/13 mm)	Ø 13.9	20	48.4
A00000499	STT-W12-D160-A Block	Round bottom tubes (15/16 mm)	Ø 17.5	12	48.4
A00000500	STT-W12-D180-A Block	Round bottom tubes (17/18 mm)	Ø 19.1	12	48.4
A00000501	STT-W08-D200-A Block	Round bottom tubes (20 mm)	Ø 21	8	48.4
A00000502	STT-W06-D250-A Block	Round bottom tubes (25 mm)	Ø 26.2	6	48.4
A00000503	STT-W04-D350-A Block	Round bottom tubes (35 mm)	Ø 35	4	47.6

STT-W30-D060-A

Block for Standard test tubes

Code A00000495

- Tube type: 6 mm round-bottom tubes
- Number of wells: 30
- Well depth: 48.4 mm
- Well size: Ø 8.3 mm
- Block dimensions (WxHxD): 76x51x95 mm

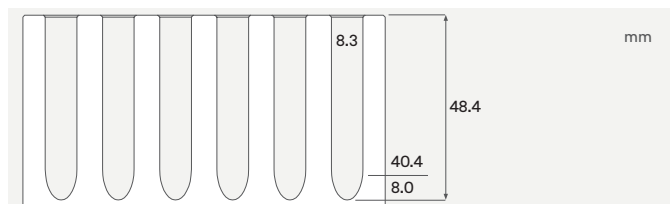

STT-W24-D100-A

Block for Standard test tubes

Code A00000496

- Tube type: 10 mm round-bottom tubes
- Number of wells: 24
- Well depth: 48.4 mm
- Well size: Ø 10.7 mm
- Block dimensions (WxHxD): 76x51x95 mm

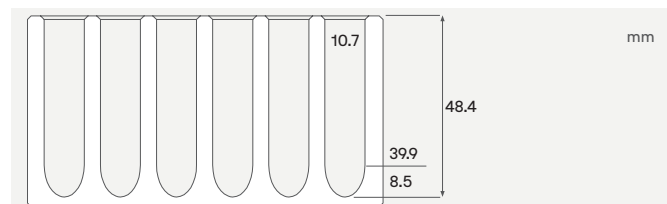

STT-W16-D130-A

Block for Standard test tubes

Code A00000497

- Tube type: 12/13 mm round-bottom tubes
- Number of wells: 16
- Well depth: 48.4 mm
- Well size: Ø 13.9 mm
- Block dimensions (WxHxD): 76x51x95 mm

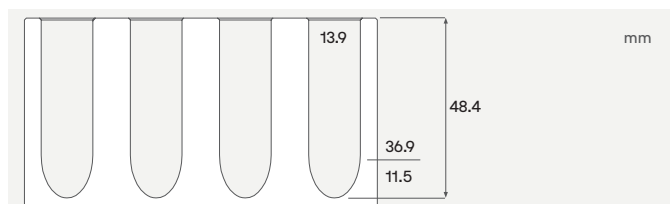

STT-W20-D130-A

Block for Standard test tubes

Code A00000498

- Tube type: 12/13 mm round-bottom tubes
- Number of wells: 20
- Well depth: 48.4 mm
- Well size: Ø 13.9 mm
- Block dimensions (WxHxD): 76x51x95 mm

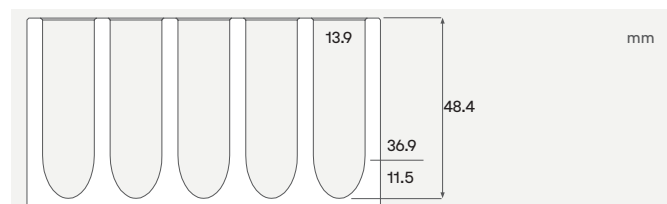

STT-W12-D160-A

Block for Standard test tubes

Code A00000499

- Tube type: 15/16 mm round-bottom tubes
- Number of wells: 12
- Well depth: 48.4 mm
- Well size: Ø 17.5 mm
- Block dimensions (WxHxD): 76x51x95 mm

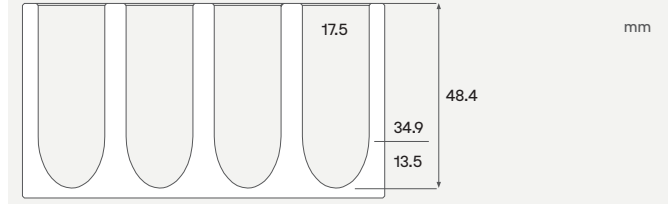

STT-W12-D180-A

Block for Standard test tubes

Code A00000500

- Tube type: 17/18 mm round-bottom tubes
- Number of wells: 12
- Well depth: 48.4 mm
- Well size: Ø 19.1 mm
- Block dimensions (WxHxD): 76x51x95 mm

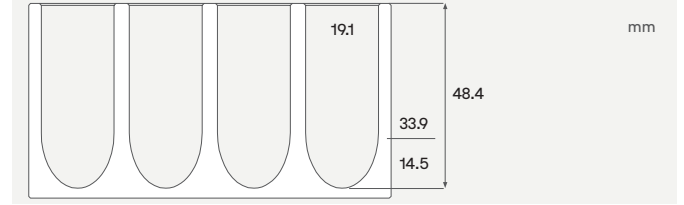

STT-W08-D200-A

Block for Standard test tubes

Code A00000501

- Tube type: 20 mm round-bottom tubes
- Number of wells: 8
- Well depth: 48.4 mm
- Well size: Ø 21 mm
- Block dimensions (WxHxD): 76x51x95 mm

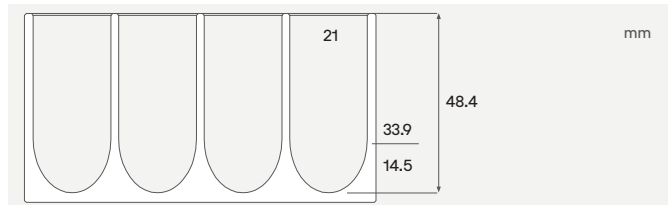

STT-W06-D250-A

Block for Standard test tubes

Code A00000502

- Tube type: 25 mm round-bottom tubes
- Number of wells: 6
- Well depth: 48.4 mm
- Well size: Ø 26.2 mm
- Block dimensions (WxHxD): 76x51x95 mm

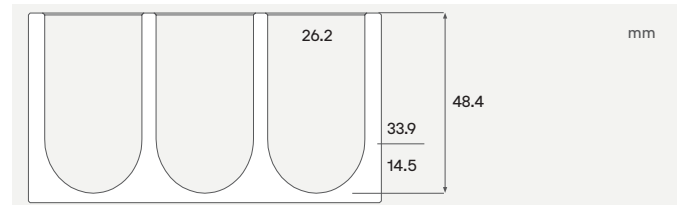

STT-W04-D350-A

Block for Standard test tubes

Code A00000503

- Tube type: 35 mm round-bottom tubes
- Number of wells: 4
- Well depth: 47.6 mm
- Well size: Ø 35 mm
- Block dimensions (WxHxD): 76x51x95 mm

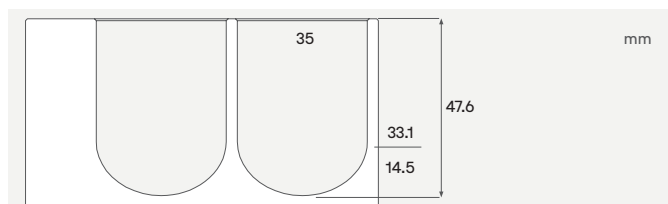

Blocks for Micro Centrifuge Tubes

Designed for small-volume samples, typically employed in molecular biology and biochemistry for DNA, RNA, or protein preparation and analysis.

Velp code	Description	Suitable for	Well Size	No. of Wells	Well Depth
A00000504	MCT-W30-V005-A Block	PCR tubes (0.5 ml)	Ø 7.9	30	27.6
A00000505	MCT-W20-V015-A Block	Microcentrifuge tubes (1.5 ml)	Ø 11.5	20	36.9
A00000506	MCT-W20-V015-B Block	Microcentrifuge tubes (1.5 ml)	Ø 10.9	20	39.1
A00000507	MCT-W20-V020-A Block	Microcentrifuge tubes (2.0 ml)	Ø 10.9	20	38.1
A00000508	MCT-W20-V020-B Block	Microcentrifuge tubes (2.0 ml)	Ø 10.9	20	38.1

MCT-W30-V005-A

Block for Micro centrifuge tubes

Code **A00000504**

- Tube type: PCR tubes (0.5 ml)
- Number of wells: 30
- Well depth: 27.6 mm
- Well size: Ø 7.9 mm
- Block dimensions (WxHxD): 76x51x95 mm

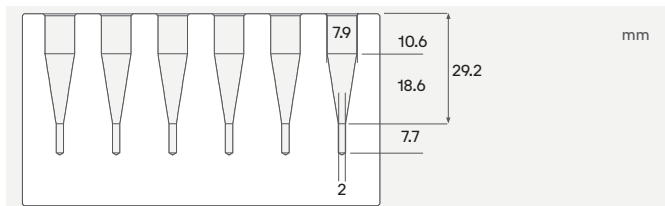

MCT-W20-V015-A

Block for Micro centrifuge tubes

Code **A00000505**

- Tube type: Microcentrifuge tubes (1.5 ml)
- Number of wells: 20
- Well depth: 36.9 mm
- Well size: Ø 11.5 mm
- Block dimensions (WxHxD): 76x51x95 mm

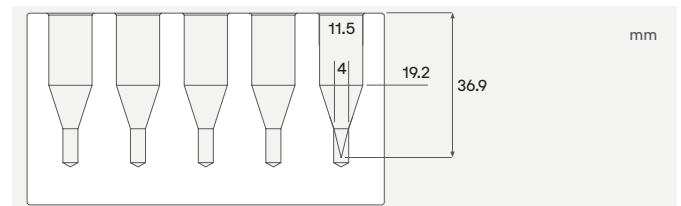

MCT-W20-V015-B

Block for Micro centrifuge tubes

Code **A00000506**

- Tube type: Microcentrifuge tubes (1.5 ml)
- Number of wells: 20
- Well depth: 39.1 mm
- Well size: Ø 10.9 mm
- Block dimensions (WxHxD): 76x51x95 mm

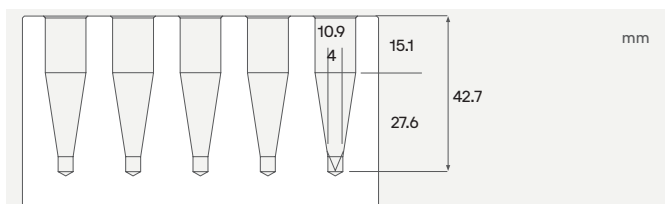

MCT-W20-V020-A

Block for Micro centrifuge tubes

Code **A00000507**

- Tube type: Microcentrifuge tubes (2.0 ml)
- Number of wells: 20
- Well depth: 38.1 mm
- Well size: Ø 10.9 mm
- Block dimensions (WxHxD): 76x51x95 mm

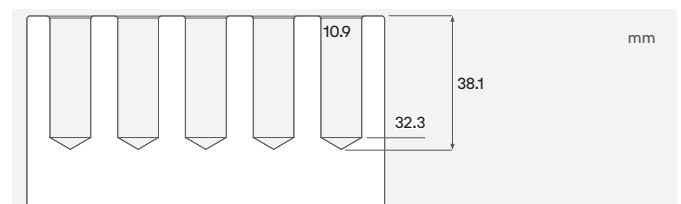

MCT-W20-V020-B

Block for Micro centrifuge tubes

Code **A00000508**

- Tube type: Microcentrifuge tubes (2.0 ml)
- Number of wells: 20
- Well depth: 38.1 mm
- Well size: \varnothing 10.9 mm
- Block dimensions (WxHxD): 76x51x95 mm

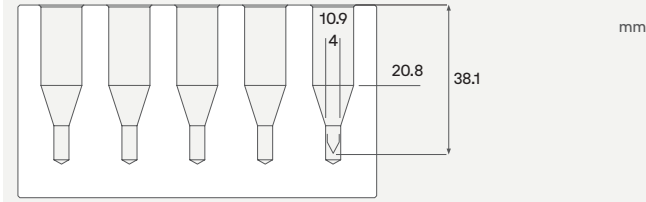

Blocks for Cuvette

Allow controlled heating of cuvettes for spectrophotometric analysis, supporting kinetic studies, enzyme reactions, or temperature-dependent absorbance measurements.

Velp code	Description	Suitable for	Well Size	No. of Wells	Well Depth
A00000526	CUV-W12-D125-A Block	2 x 6 cuvettes (12.5 mm)	-	2	25.4

CUV-W12-D125-A

Block for Cuvette

Code **A00000526**

- 2 x 6 cuvettes (12.5 mm)
- Number of wells: 2
- Well depth: 25.4 mm
- Block dimensions (WxHxD): 76x51x95 mm

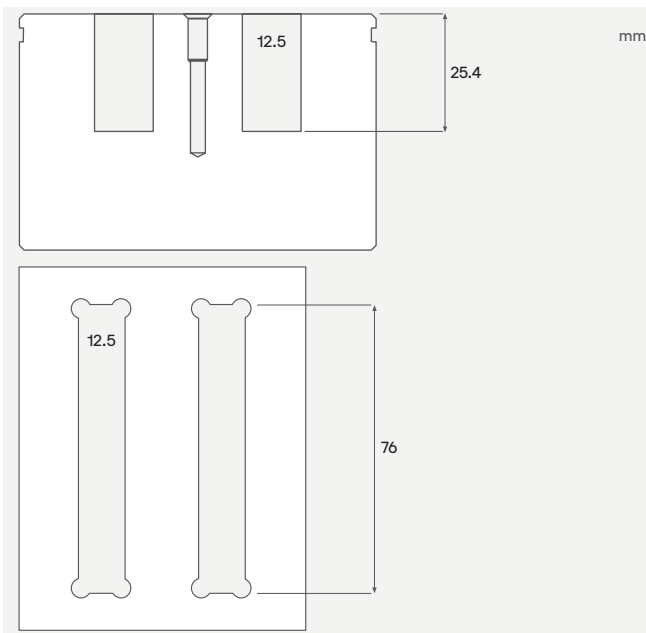

Blocks for Conical Bottom Centrifuge Tubes

Used for medium to large capacity centrifugations, ideal for separating cells, particles, or biological components, as well as for preparing and collecting pellets.

Velp code	Description	Suitable for	Well Size	No. of Wells	Well Depth
A00000509	CCT-W12-V150-A Block	Conical centrifuges tube (15 ml)	Ø 17.1	12	44.5
A00000510	CCT-W05-V500-A Block	Conical centrifuges tube (50 ml)	Ø 29	5	47.6

CCT-W12-V150-A

Block for conical centrifuges tube
Code A00000509

- Conical centrifuges tube (15 ml)
- Number of wells: 12
- Well depth: 44.5 mm
- Well size: Ø 17.1 mm
- Block dimensions (WxHxD): 76x51x95 mm

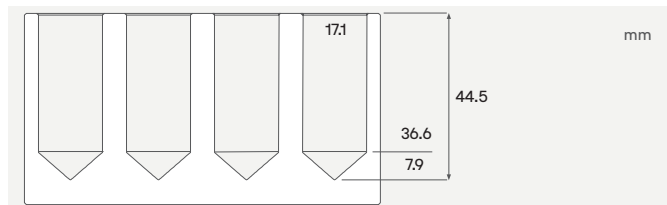

CCT-W05-V500-A

Block for conical centrifuges tube
Code A00000510

- Conical centrifuge tubes (50 ml)
- Number of wells: 5
- Well depth: 47.6 mm
- Well size: Ø 29 mm
- Block dimensions (WxHxD): 76x51x95 mm

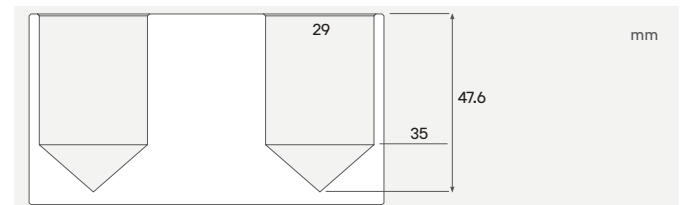

Combination Blocks

Provide maximum flexibility, allowing simultaneous heating of different tube formats, ideal for multipurpose laboratories handling diverse workflows.

Velp code	Description	Suitable for	Well Size	No. of Wells	Well Depth
A00000511	STT-W14-COMBO Block	Test tube combination, 6 / 12 / 13 / 25 mm	Ø 8.3	6	48.4
			Ø 13.9	5	48.4
			Ø 26.2	3	48.4
A00000512	CCT-W09-COMBO Block	Centrifuge tube combination, 1.5 / 15 / 50 ml	Ø 11.1	4	39.1
			Ø 17.1	3	44.5
			Ø 29	2	47.6
A00000513	MCT-W21-COMBO Block	Microcentrifuge tube combination, 0.5 / 1.5 / 2.0 ml	Ø 7.9	6	27.6
			Ø 11.1	10	39.1
			Ø 11.5	5	38.1

STT-W14-COMBO Block

Block for Standard test tubes

Code **A00000511**

- Test tube combination, 6/12/13/25 mm
- Number of wells: 6/5/3
- Well depth: 48.4/ 48.4/ 48.4 mm
- Well size: Ø 8.3/13.9/26.2 mm
- Block dimensions (WxHxD): 76x51x95 mm

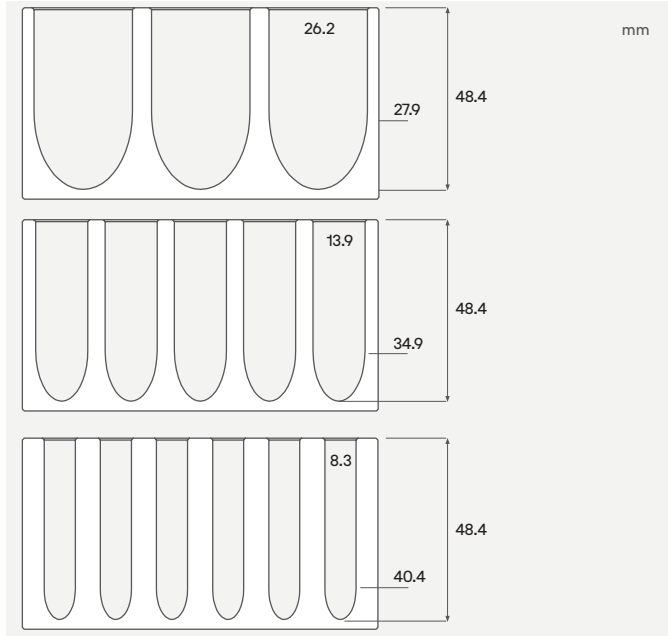

CCT-W09-COMBO Block

Block for Conical centrifuges tubes

Code **A00000512**

- Centrifuge tube combination 1.5/15/50 ml
- Number of wells: 4/3/2
- Well depth: 39.1/44.5/47.6 mm
- Well size: Ø 11.1/17.1/29 mm
- Block dimensions (WxHxD): 76x51x95 mm

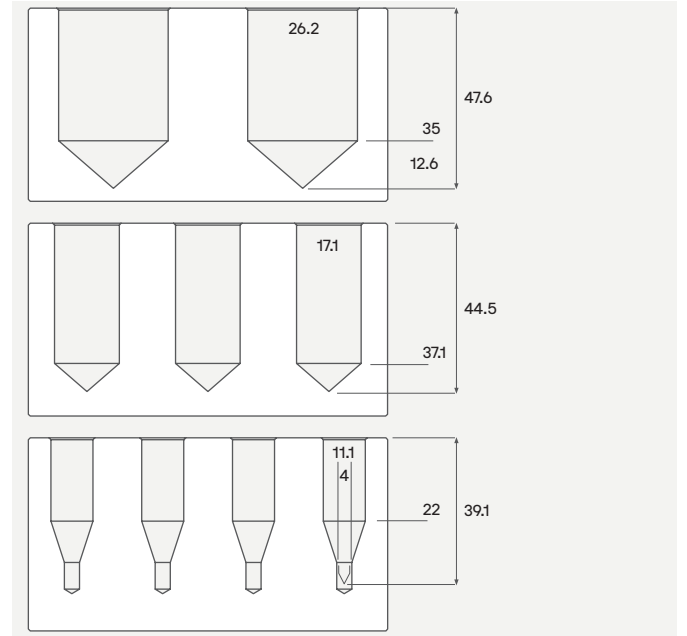

MCT-W21-COMBO

Block for microcentrifuge tube

Code **A00000513**

- Centrifuge tube combination 7.9/11.1/11.5 ml
- Number of wells: 6/10/5
- Well depth: 27.6/39.1/38.1 mm
- Well size: Ø 7.9/11.1/11.5 mm
- Block dimensions (WxHxD): 76x51x95 mm

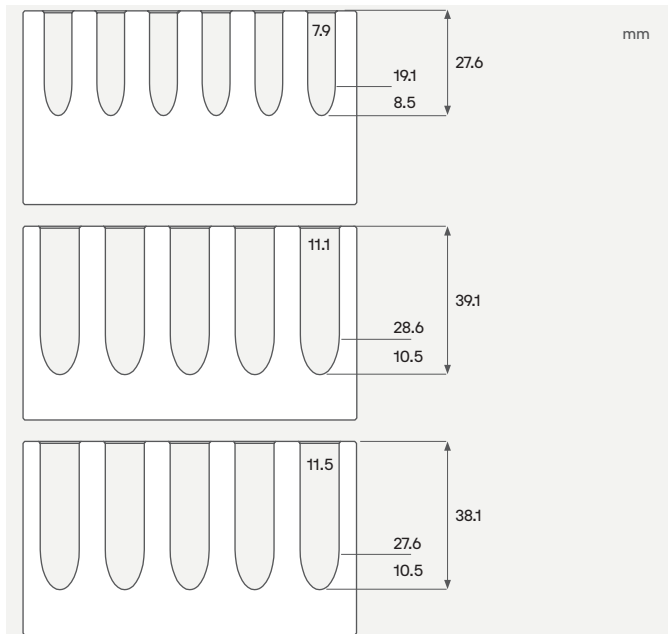

Blocks for Vials

Suitable for reaction vials, often used in chemistry and pharmaceutical applications for compound synthesis, extraction, or sample preparation.

Velp code	Description	Suitable for	Well Size	No. of Wells	Well Depth
A00000514	VLS-W20-D120-A Block	12 mm vials	Ø 12.7	20	30
A00000515	VLS-W20-D150-A Block	15 mm vials	Ø 15.8	20	35
A00000516	VLS-W15-D160-A Block	16 mm vials	Ø 16.4	15	45
A00000517	VLS-W12-D170-A Block	17 mm vials	Ø 17.8	12	45
A00000518	VLS-W12-D190-A Block	19 mm vials	Ø 19.7	12	45
A00000519	VLS-W09-D210-A Block	21 mm vials	Ø 21.7	9	45
A00000520	VLS-W08-D230-A Block	23 mm vials	Ø 23.8	8	45
A00000521	VLS-W08-D250-A Block	25 mm vials	Ø 25.8	8	45
A00000522	VLS-W06-D280-A Block	28 mm vials	Ø 28.8	6	45

VLS-W20-D120-A

Block for Vials

Code A00000514

- Tube type: 12 mm vials
- Number of wells: 20
- Well depth: 30 mm
- Well size: Ø 12.7 mm
- Block dimensions (WxHxD): 76x51x95 mm

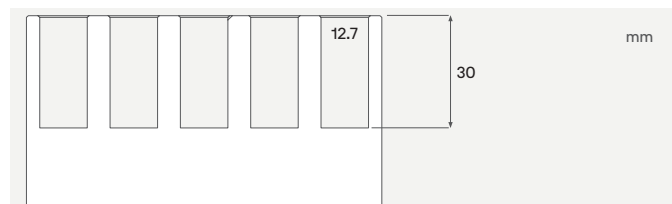

VLS-W20-D150-A

Block for Vials

Code A00000515

- Tube type: 15 mm vials
- Number of wells: 20
- Well depth: 35 mm
- Well size: Ø 15.8 mm
- Block dimensions (WxHxD): 76x51x95 mm

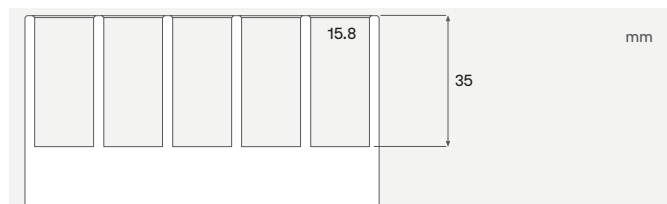

VLS-W15-D160-A

Block for Vials

Code A00000516

- Tube type: 16 mm vials
- Number of wells: 15
- Well depth: 45 mm
- Well size: Ø 16.4 mm
- Block dimensions (WxHxD): 76x51x95 mm



VLS-W12-D170-A

Block for Vials

Code A00000517

- Tube type: 17 mm vials
- Number of wells: 12
- Well depth: 45 mm
- Well size: Ø 17.8 mm
- Block dimensions (WxHxD): 76x51x95 mm

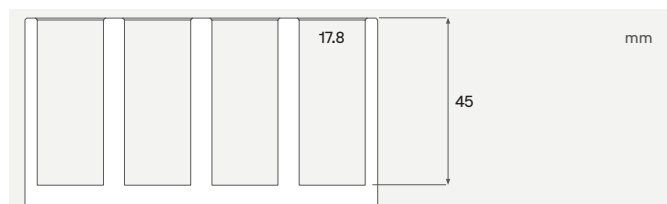

VLS-W12-D190-A

Block for Vials

Code A00000518

- Tube type: 19 mm vials
- Number of wells: 12
- Well depth: 45 mm
- Well size: \varnothing 19.7 mm
- Block dimensions (WxHxD): 76x51x95 mm

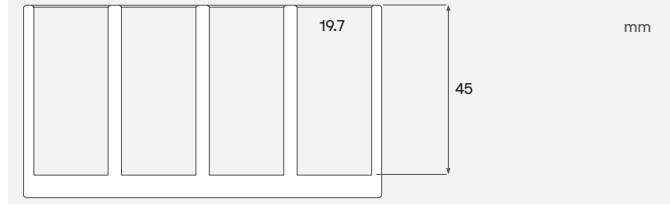

VLS-W09-D210-A

Block for Vials

Code A00000519

- Tube type: 21 mm vials
- Number of wells: 9
- Well depth: 45 mm
- Well size: \varnothing 21.7 mm
- Block dimensions (WxHxD): 76x51x95 mm

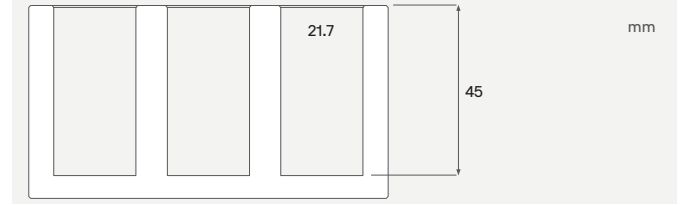

VLS-W08-D230-A

Block for Vials

Code A00000520

- Tube type: 23 mm vials
- Number of wells: 8
- Well depth: 45 mm
- Well size: \varnothing 23.8 mm
- Block dimensions (WxHxD): 76x51x95 mm

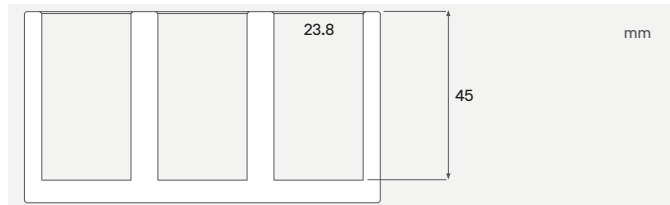

VLS-W08-D250-A

Block for Vials

Code A00000521

- Tube type: 25 mm vials
- Number of wells: 8
- Well depth: 45 mm
- Well size: \varnothing 25.8 mm
- Block dimensions (WxHxD): 76x51x95 mm

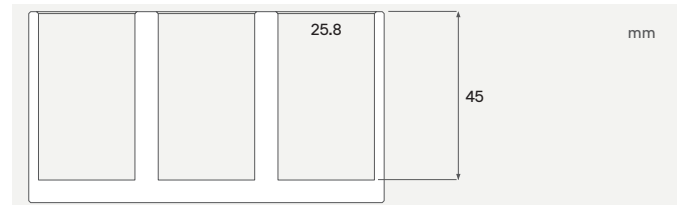

VLS-W06-D280-A

Block for Vials

Code A00000522

- Tube type: 28 mm vials
- Number of wells: 6
- Well depth: 45 mm
- Well size: \varnothing 28.8 mm
- Block dimensions (WxHxD): 76x51x95 mm

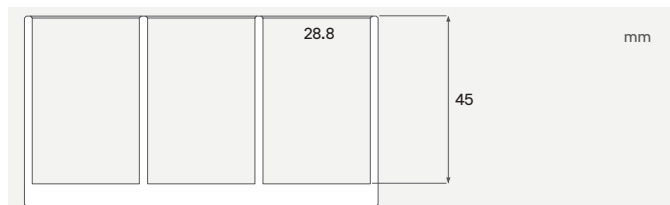

Blocks for PCR

Specially designed for PCR (Polymerase Chain Reaction) applications, ensuring uniform heating and precise temperature control during DNA amplification and related molecular biology workflows, as well as diagnostics and genetic research.

Velp code	Description	Suitable for	Well Size	No. of Wells	Well Depth
A00000523	PCR-W64-V002-A Block	64 × individual PCR tubes (0.2 ml tubes)	Ø 6.6	64	20.2
A00000524	PCR-W80-V002-A Block	10 × 8 individual PCR tube strips (0.2 ml tubes)	Ø 6.6	80	15.5
A00000525	PCR-W96-V002-A Block	1 × 96 – well PCR plate (0.2 ml tubes)	Ø 6.6	96	15.5

PCR-W64-V002-A

Block for PCR

Code **A00000523**

- Tube type: Individual PCR tubes (0.2 ml tubes)
- Number of wells: 64
- Well depth: 20.2 mm
- Well size: Ø 6.4 mm
- Block dimensions (WxHxD): 76x51x95 mm

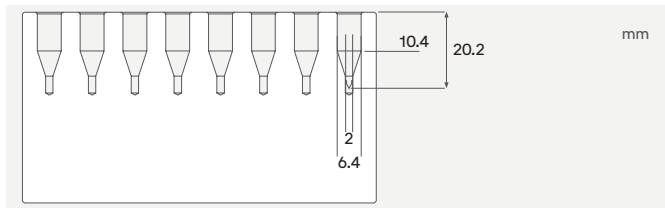

PCR-W80-V002-A

Block for PCR

Code **A00000524**

- Tube type: Individual PCR tube strips (0.2 ml tubes)
- Number of wells: 80
- Well depth: 15.5 mm
- Well size: Ø 6.6 mm
- Block dimensions (WxHxD): 76x51x95 mm

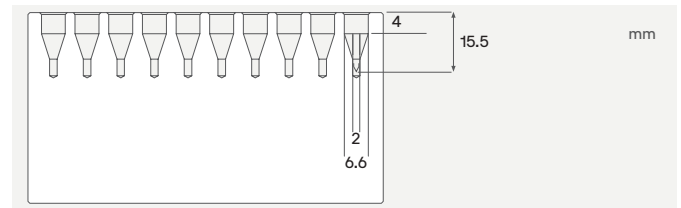

PCR-W96-V002-A

Block for Vials

Code **A00000525**

- Tube type: PCR plate (0.2 ml tubes)
- Number of wells: 96
- Well depth: 15.5 mm
- Well size: Ø 6.6 mm
- Block dimensions (WxHxD): 152x51x95 mm

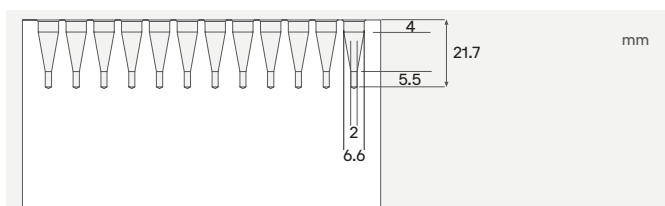

Blocks for COD

Dedicated to COD (Chemical Oxygen Demand) analysis in environmental testing, ensuring accurate digestion of water and wastewater samples under controlled conditions.

Velp code	Description	Suitable for	Well Size	No. of Wells	Well Depth
A00000529	COD-W04-D420-A Block	Round bottom COD test tube (42mm)	Ø 42	4	51
A00000530	COD-W20-COMBO Block	Round bottom COD test tube (16/22mm)	Ø 16 Ø 22	18 2	47 45.5
A00000494	COD-W24-D160-A Block	Round bottom COD test tube (16mm)	Ø 16	24	47

COD-W04-D420-A

Block for COD

Code **A00000529**

- Tube type: Round bottom COD test tube (42mm)
- Number of wells: 4
- Well depth: 42 mm
- Well size: Ø 51 mm
- Block dimensions (WxHxD): 152x51x95 mm

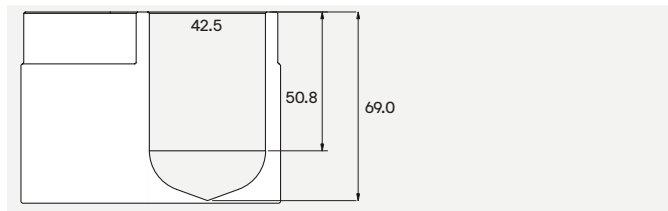

COD-W20-COMBO

Block for COD

Code **A00000530**

- Tube type: Round bottom COD test tube (6 / 22mm)
- Number of wells: 20
- Well depth: 47 / 45.5 mm
- Well size: Ø 16 / 22 mm
- Block dimensions (WxHxD): 152x51x95 mm

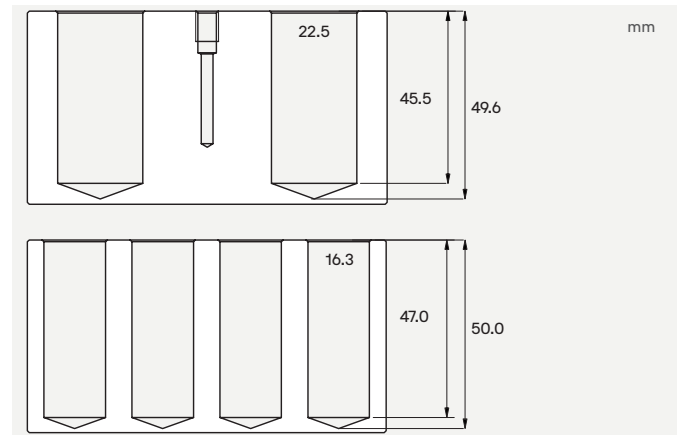

COD-W24-D160-A

Block for COD

Code **A00000494**

- Tube type: Round bottom COD test tube (16mm)
- Number of wells: 24
- Well depth: 47 mm
- Well size: Ø 16
- Block dimensions (WxHxD): 152x51x95 mm

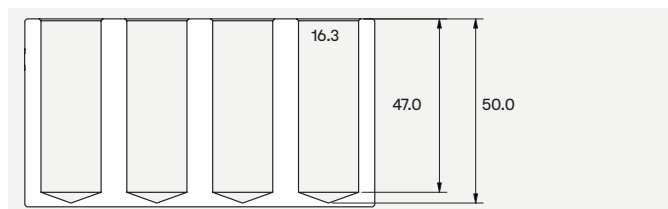

Technical Data

	ECODryBlock
User interface	Digital
Set-up plate material	Aluminium alloy
Temperature range	Room temp. +5°C - 165°C (0,5 °C steps)
External temperature sensor connection	Pt100, Pt1000 Probes
Temperature stability within the blocks at 37°C	±0.2 °C
Temperature homogeneity at 37°C	±0.2 °C
Temperature stability within the blocks at 60°C	±0.4 °C
Temperature homogeneity at 60°C	±0.4 °C
Temperature stability within the blocks at 165°C	±0.5 °C
Temperature homogeneity at 165°C	±0.5 °C
Timer	Yes - 1 min - 99 h 59 min
Hot plate warning system	On Display (when the temperature is above 50 °C)
Weight	2.1 kg (4.6 lb)
Weight no ControlPad	1.3 kg (2.9 lb)
Dimensions (WxHxD)	228x92.5x350 mm (8.97x3.64x13.77 in)
Dimensions (WxHxD) no ControlPad	207x92.5x195 mm (8.15x3.64x7.68 in)

Service & Support

Velp products are designed by our engineers to resist years of laboratory use.

Our products are manufactured with premium materials to guarantee the best performance with maximum safety.

According to our experience, a proper and regular maintenance is necessary to ensure the highest performance of analytical instrument. Velp Service Department and Velp Official Partners are always ready to offer you maintenance and service support tailored to your needs.

Get the support you need choosing the options:

- Help-desk and Remote support
- Technical Assistance
- Analytical Support

We reserve the right to make technical alterations
We do not assume liability for errors in printing, typing or transmission



Headquarters
Velp Scientifica Srl
Via Stazione 16
20865 Usmate (MB)
Italia
T +39 039 628811
velpitalia@velp.com

India
velpindia@velp.com

USA
Velp Scientific Inc
40, Burt Drive, Unit #1,
Deer Park
NY 11729 - U.S.
T +1 631 573 6002
velpusa@velp.com

LATAM
velplatam@velp.com

China
Velp China Co. Ltd.
Room 828, Building 1, No.778
Jinji Road, Pudong New Area,
Shanghai, China
Tel. +8621 34500630
velpchina@velp.com

SEA & Pacific
velpsea@velp.com

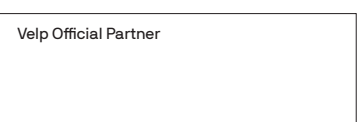

Rev 3.1.2026

